

# Color Controller RC-200

OPERATING INSTRUCTIONS  
PRINTER REFERENCE

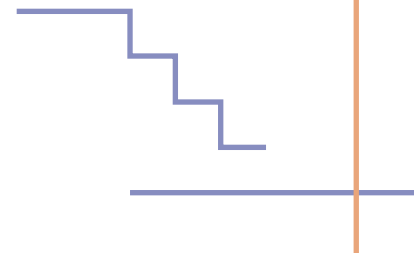
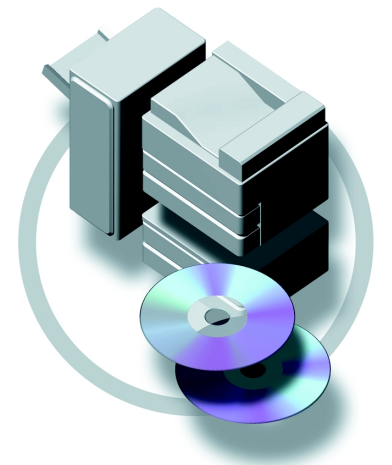

## **Introduction**

This manual contains detailed instructions on the operation and maintenance of this machine. To get maximum versatility from this machine all operators should carefully read and follow the instructions in this manual.

Please read the Safety Information in the "Copy Reference" before using this machine. It contains important information related to USER SAFETY and PREVENTING EQUIPMENT PROBLEMS.

## **Important**

Parts of this manual are subject to change without prior notice. In no event will the company be liable for direct, indirect, special, incidental, or consequential damages as a result of handling or operating the machine.

## **Trademarks**

RICOH-SCRIPT2® is a registered trademark of Ricoh Company.

Microsoft® and Windows® are registered trademarks of Microsoft Corporation in the United States and/or other countries.

Ethernet® is a registered trademark of Xerox Corporation.

Adobe®, PostScript®, Acrobat® and PageMaker® are registered trademarks of Adobe System Incorporated.

AppleTalk, Apple, Macintosh, TrueType, LaserWriter and ColorSync are registered trademarks of Apple Computer, Incorporated.

Other product names used herein are for identification purposes only and might be trademarks of their respective companies. We disclaim any and all rights in those marks.

## **Warning:**

Use of controls or adjustment or performance of procedures other than those specified in this manual might result in hazardous radiation exposure.

## **Notes:**

Some illustrations might be slightly different from your machine.

Certain options might not be available in some countries. For details, please contact your local dealer.

## **Note**

The proper names of Windows operating system are as follows:

- Microsoft® Windows® 95 operating system
- Microsoft® Windows® 98 operating system
- Microsoft® Windows NT® Server operating system Version 4.0
- Microsoft® Windows NT® Workstation operating system Version 4.0

## Note to users in the United States of America

### Notice:

This equipment has been tested and found to comply with the limits for a Class B digital device, pursuant to Part 15 of the FCC Rules. These limits are designed to provide reasonable protection against harmful interference in a residential installation. This equipment generates, uses and can radiate radio frequency energy and, if not installed and used in accordance with the instructions, may cause harmful interference to radio communications.

However, there is no guarantee that interference will not occur in a particular installation. If this equipment does cause harmful interference to radio or television reception, which can be determined by turning the equipment off and on, the user is encouraged to try to correct the interference by one more of the following measures:

**Reorient or relocate the receiving antenna.**

**Increase the separation between the equipment and receiver.**

**Connect the equipment into an outlet on a circuit different from that to which the receiver is connected.**

**Consult the dealer or an experienced radio/TV technician for help.**

### Warning

Changes or modifications not expressly approved by the party responsible for compliance could void the user's authority to operate the equipment.

### Caution (in case of 100BASE-TX environment):

Properly shielded and grounded cables (STP) and connectors must be used for connections to host computer (and/or peripheral) in order to meet FCC emission limits.

STP with ferrite core must be used for RF interference suppression.

### Declaration of Conformity

Product Name: Printer Controller

Model Number: Color Controller RC-200

Responsible party: Ricoh Corporation

Address: 5 Dedrick Place, West Caldwell, NJ 07006

Telephone number: 973-882-2000

This device complies with part 15 of FCC Rules.

Operation is subject to the following two conditions:

1. This device may not cause harmful interference, and
2. this device must accept any interference received, including interference that may cause undesired operation.

### Note to users in Canada

#### Note:

This Class B digital apparatus complies with Canadian ICES-003.

#### Remarque concernant les utilisateurs au Canada

#### Avertissement:

Cet appareil numérique de la classe B est conforme à la norme NMB-003 du Canada.

# Manuals for this Machine

There are five manuals that describe the operational procedures separately for the operation and maintenance of the machine.

This manual, the Printer Reference, contains detailed instructions for using this machine as a printer.

To ensure safe and efficient operation of the machine, all users should read and follow the instructions contained in the following manuals.

- ❖ **Operating Instructions that Describes the Copy Functions**

Describes the procedures and functions for using this machine as a copier.

- ❖ **Printer Reference Provided as a Paper Manual**

Describes the system settings, procedures and functions for using this machine as a printer. (This Manual)

- ❖ **Printer Reference Provided as a PDF File**

Describes the procedures and provides necessary information on using this machine as a printer. The manual is included as a PDF file in the CD-ROM.

- ❖ **RICOH-SCRIPT2 Operating Instructions**

Describes the menus and features you can set using the RICOH-SCRIPT2 printer driver. The manual is included as a PDF file in the CD-ROM.

- ❖ **Network Interface Board Operating Instructions**

Describes the procedures and provides necessary information on setting up and using the printer under the network environment. The manual is included as a PDF file in the CD-ROM.

# How to Read this Manual

---

## Symbols

---

In this manual, the following symbols are used:

 **WARNING:**

This symbol indicates a potentially hazardous situation which, if instructions are not followed, could result in death or serious injury.

 **CAUTION:**

This symbol indicates a potentially hazardous situation which, if instructions are not followed, may result in minor or moderate injury or damage to property.

\* The statements above are notes for your safety.

 **Important**

If this instruction is not followed, paper might be misfed, originals might be damaged, or data might be lost. Be sure to read this.

 **Preparation**

This symbol indicates the prior knowledge or preparations required before operating.

 **Note**

This symbol indicates precautions for operation, or actions to take after misoperation.

 **Limitation**

This symbol indicates numerical limits, functions that cannot be used together, or conditions in which a particular function cannot be used.

 **Reference**

This symbol indicates a reference.

[    ]

Keys that appear on the machine's panel display.

Keys and buttons that appear on the computer's display.

【    】

Keys built into the machine's operation panel.

Keys on the computer's keyboard.

# TABLE OF CONTENTS

## 1. Getting Started

---

<b>Connecting the Machine</b> .....	<b>1</b>
Requirements .....	1
Connecting the Machine Using the Network Interface Board .....	3
Connecting the Machine to the Host Using a Parallel Cable .....	4
<b>Features of this Machine</b> .....	<b>6</b>
Printer Drivers for this Machine .....	7
Software and Utilities Included in the CD-ROM .....	7
<b>Guide to this Machine</b> .....	<b>9</b>
Operation Panel .....	9

## 2. Configuring the Printer for the Network with the Operation Panel

---

<b>Configuring the Printer for the Network with the Operation Panel</b> .....	<b>13</b>
---	-----------

## 3. Installing the Printer Driver and Software

---

<b>Before Installing</b> .....	<b>20</b>
<b>Auto Run Program</b> .....	<b>21</b>
Installing by Auto Run .....	21
<b>Installing the IPDL-C Printer Driver</b> .....	<b>23</b>
Windows 95/98 - Installing the IPDL-C Printer Driver .....	23
Windows NT 4.0 - Installing the IPDL-C Printer Driver .....	24
<b>Installing the RICOH-SCRIPT2 Printer Driver</b> .....	<b>25</b>
Windows 95/98 - Installing the RICOH-SCRIPT2 Printer Driver .....	25
Windows NT 4.0 - Installing the RICOH-SCRIPT2 Printer Driver .....	27
Using Adobe PageMaker Version 6.0 or 6.5 in Windows .....	30
Macintosh .....	31
<b>INDEX</b> .....	<b>36</b>



# 1. Getting Started

## Connecting the Machine

Confirm that the shape and the position of the connectors are as shown in the illustration.

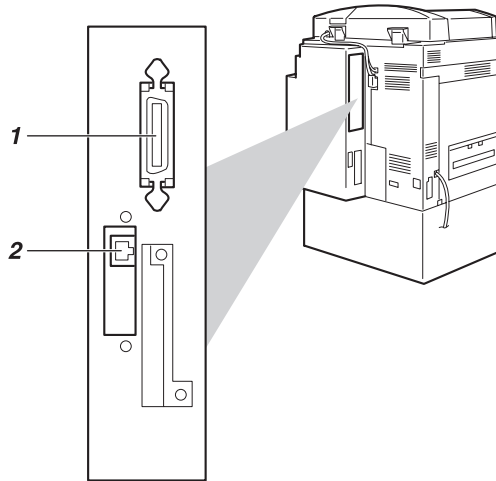

TBEH010N

1. Parallel Port

2. 10BASE-T/100BASE-TX

---

## Requirements

---

---

### Requirements

---

Before using this machine, confirm that all the environmental and electrical requirements have been met. Connect the machine to your host computer using the Parallel Port, Network Interface Board, or both.

Confirm that all the cables, connectors, and electrical outlets necessary to attach the machine to your host computer or network are present.

### Reference

For more information on using the Parallel Port, see P.4 *“Connecting the Machine to the Host Using a Parallel Cable”*

For more information on using a network, see P.2 *“Network connections”*



**Network connections**

The Network Interface Board supports 10BASE-T or 100BASE-TX connections.

You can use the machine in the following network environments:

- Using the appropriate network management software and printer driver.
- Attaching the machine to a networked computer set up as a server.

<b>Client</b>	Windows 95, 98, NT 4.0 *1 , Mac OS 7.6~8.6 *2
<b>Driver</b>	IPDL-C, RICOH-SCRIPT2
<b>File Server</b>	NetWare 3.x, NetWare 4.x, NetWare 5
<b>Protocol</b>	IPX/SPX, TCP/IP, AppleTalk, NetBEUI *3

\*1 Under Windows NT 4.0, only x86 CPU is supported.

\*2 Only RICOH-SCRIPT2 is available.

\*3 Under Windows 95/98/NT 4.0 only.

In a mixed network environment, the protocol switches automatically.

 **Reference**

For more information on resolving network connection problems, see the "Operating Instructions" of Network Interface Board included as a PDF file in the CD-ROM.

 **Note**

- Consult your network administrator before connecting the machine to a network.

 **Important**

- Rating voltage of the 10BASE-T/100BASE-TX connector; Max. DC 5V.

**Parallel cable requirements**

Connect the machine to the host computer using a Parallel Port. This machine does not provide the parallel cable to connect the machine to the host computer.

The machine's parallel interface is a standard bi-directional interface. It requires a standard 36-pin parallel cable compliant with IEEE 1284 and a Parallel Port available on the host computer.

 **Note**

- Do not use a parallel cable that is longer than 2.5 meters (8.2 feet).

 **Important**

- Rating voltage of the parallel interface connector for the computer; Max. DC 5V.

## Connecting the Machine Using the Network Interface Board

Connect the machine to the network using the Network Interface Board.

Follow these steps to connect the machine.

### 1 Confirm that you have the correct cable.

#### Note

- In a 100BASE-TX environment, be sure to use a properly shielded and grounded cable (STP) for the connection to your host computer (and/or HUB) in order to meet FCC and EMC Directive 89/336/EEC emission guidelines.

### 2 Confirm that the machine is turned off.

### 3 Loop the network interface cable. The loop should be about 15 cm (6") from the end of the cable on the end closest to the printer.

### 4 Attach the ferrite core to the loop.

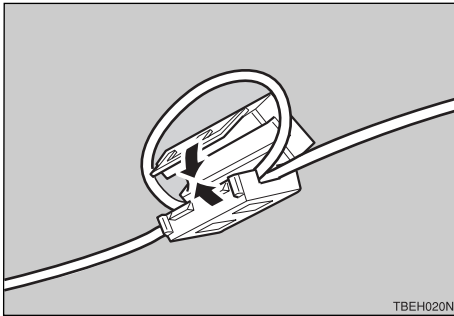

### 5 Attach the network interface cable to the 10BASE-T/100BASE-TX port on the printer.

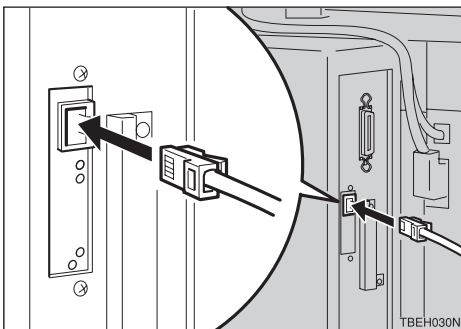

#### Reference

See P.1 "Connecting the Machine" to be sure of the position of the 10BASE-T/100BASE-TX port.

 **Note**

- Confirm that the cable is connected to the 10BASE-T/100BASE-TX port.

 **Important**

- Rating voltage of the 10BASE-T/100BASE-TX connector; Max. DC 5V.

**6** Connect the other end of the cable to the network.

---

### Indicators on the Network Interface Board

---

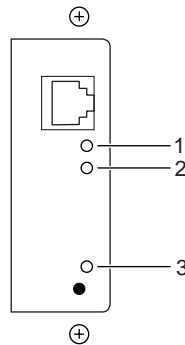

**1. Indicator (green)**

Is on while the machine is in a network environment.

**2. Indicator (green)**

Is on while the 100BASE-TX is working.  
Stays off while 10BASE-T is working.

**3. Indicator (orange)**

Is on while the Network Interface Board is working.

---

### Connecting the Machine to the Host Using a Parallel Cable

---

Connect the machine to the host computer using a parallel cable compliant with IEEE 1284 (supplied by you).

Follow these steps to connect the machine to your host computer.

**1** Confirm that you have the correct cable.

**2** Confirm that both the machine and the host computer are turned off.

- 3 Plug the 36-pin end of the parallel cable into the Parallel Port of the printer.

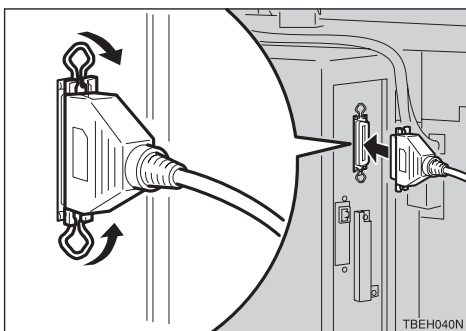

#### Reference

See P.1 "Connecting the Machine" to be sure of the position of the Parallel Port.

#### Important

- Rating voltage of the parallel interface connector for the computer; Max. DC 5V.

- 4 Squeeze the wire clips on each side of the connector together until they snap into place. The clips hold the cable securely in place.
- 5 Plug the other end of the parallel cable into the computer's Parallel Port.

# Features of this Machine

This printer is designed especially for office workgroups, both for shared usage within a network environment, and for one-to-one usage by being connected directly to your computer.

## ❖ Effective Performance with Windows

This printer provides you with rapid and high quality color printing under the Windows environment.

## ❖ PostScript Capabilities

Using RICOH-SCRIPT2 provides your printer with PostScript capabilities. You can use the printer in Windows or Macintosh environments.

## ❖ Time Saving

You can reduce the amount of time you spend printing.

- Printing Speed <sup>\*1</sup>

	Simplex machine	Duplex machine
Monochrome	14 ppm	18 ppm
Full color	4 ppm	4 ppm

<sup>\*1</sup> A4  $\square$ , 8<sup>1</sup>/<sub>2</sub>" $\times$  11"  $\square$ , maximum printing speed.

## ❖ Network Connectivity

The printer is network ready with the Network Interface Board.

## ❖ Easy Handling for Administration

You can set up User Codes for individuals or as a unit of a department. This allows you to keep records of the printing done for each User Code. You can also set up a User ID for each print job. To print a job log or a statistics report shows you color category, result and status of printing per each User Code and User ID. Viewing the contents of a job log or a statistics report through the PRINTER MANAGER is available.

Maximum 100 User Code and 64 User ID can be set.

## ❖ Major Specifications

Maximum Print Quality	600 dpi resolutions
Printer Language	IPDL-C RICOH-SCRIPT2 <sup>*1</sup>
Maximum Input Paper Size	Paper Type: A3, 11" $\times$ 17" Bypass Tray: 12" $\times$ 18"(DL+)
Standard and Maximum Memory Size	96MB

<sup>\*1</sup> Emulations

## Printer Drivers for this Machine

Printing requires installation of a printer driver for your operating system. The following drivers are included in the CD-ROM that comes with this machine.

Operating system	Printer Language	IPDL-C	RPS2 *1
Windows 95 *2		√	√
Windows 98 *3		√	√
Windows NT 4.0 *4		√	√
Mac OS *5			√

\*1 RICOH-SCRIPT2

\*2 Microsoft Windows 95 operating system

\*3 Microsoft Windows 98 operating system

\*4 Microsoft Windows NT Server operating system version 4.0, Microsoft Windows NT Workstation operating system version 4.0

\*5 Required system is 7.6 ~ 8.6.

### ❖ IPDL-C printer drivers

IPDL-C printer drivers are included in the CD-ROM that comes with this machine. IPDL-C printer drivers allow the computer to communicate with the printer via a printer language.

⇒ P.23 *“Installing the IPDL-C Printer Driver”*

⇒ P.24 *“Windows NT 4.0 - Installing the IPDL-C Printer Driver”*

### ❖ RICOH-SCRIPT2 Printer Drivers and PPD (PostScript Printer Description) files

RICOH-SCRIPT2 printer drivers and the PPD files are included in the CD-ROM that comes with this machine. RICOH-SCRIPT2 printer driver allows the computer to communicate with the printer via a printer language. The PPD files allow the printer driver to enable printer specific functions.

⇒ P.25 *“Windows 95/98 - Installing the RICOH-SCRIPT2 Printer Driver”*

⇒ P.27 *“Windows NT 4.0 - Installing the RICOH-SCRIPT2 Printer Driver”*

⇒ P.31 *“Macintosh”*

## Software and Utilities Included in the CD-ROM

### ❖ PRINTER MANAGER FOR ADMINISTRATOR

A utility for the system administrator to manage printers on the network.

#### Reference

For the name of the PRINTER MANAGER FOR ADMINISTRATOR, see the “Operation Instructions” for the Network Interface Board included as a PDF file in the CD-ROM.

See the PRINTER MANAGER FOR ADMINISTRATOR Online Help for details on using the PRINTER MANAGER FOR ADMINISTRATOR.

❖ **PRINTER MANAGER FOR CLIENT**

A utility for users to manage their own print jobs on the network.

 **Reference**

For the name of the PRINTER MANAGER FOR CLIENT, see the “Operation Instructions” for the Network Interface Board included as a PDF file in the CD-ROM.

See the PRINTER MANAGER FOR CLIENT Online Help for details on using the PRINTER MANAGER FOR CLIENT.

❖ **Multidirect Print**

A utility for printing on a "Peer-to-Peer" network.

 **Reference**

For more information on Multidirect Print, see the “Operating Instructions” for Network Interface Board included as a PDF file in the CD-ROM.

❖ **Acrobat Reader**

A utility that allows you to read PDF (Portable Document Format) files.

 **Note**

- Documentation on using the printer is included in the CD-ROM in PDF format. For details, see the Readme text in the CD-ROM or “*Manuals for this Machine*” in this manual.

# Guide to this Machine

## Operation Panel

1

### Important

- Do not press any operation panel keys while the **Data In** indicator is flashing on the operation panel.

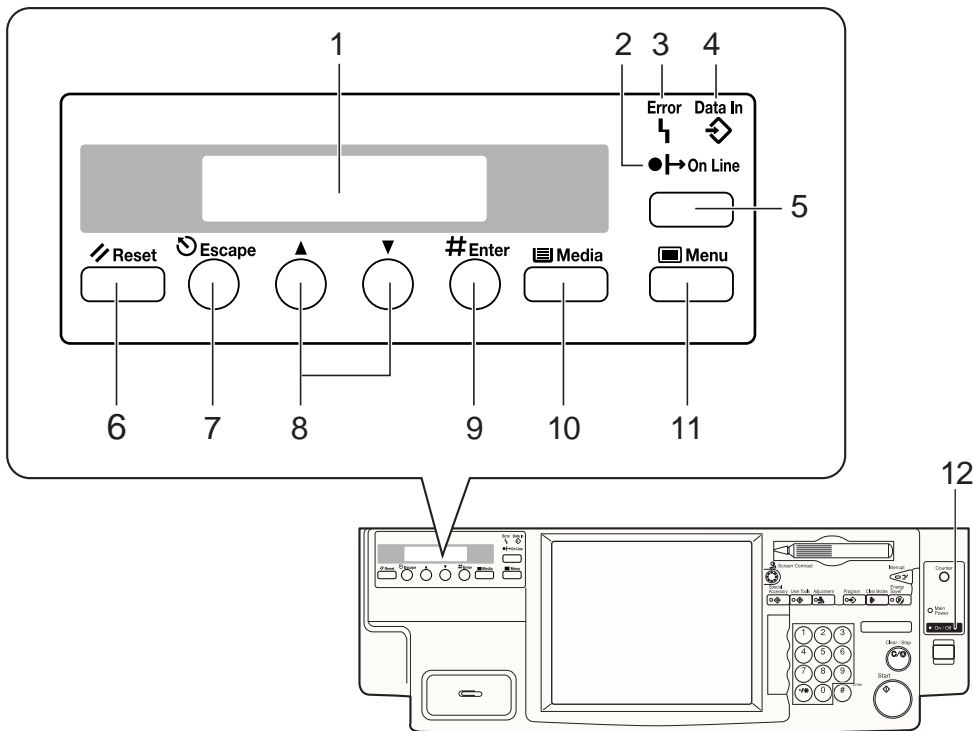

TBEH050N

### 1. Panel Display

The display shows the current status of the printer and error messages.

### 2. On Line Indicator

Tells you whether the printer is online or offline.

Is on while the printer is online (a state in which the printer can receive data from the computer).

Is off when the printer is offline (a state in which printer cannot receive data).

### 3. Error Indicator

Lights up whenever any printer error occurs. A message describing the cause of the error also appears on the panel display.

### 4. Data In Indicator

Blinks while the printer is receiving data from a computer.

Is on if there is data to be printed.



**5. [On Line] key**

Press this key to switch the printer between online and offline.

**6. [Reset] key**

Pressing this key when the printer is offline resets the printer to its power on default settings.

Pressing this key during the online condition cancels the ongoing print job.

**7. [Escape] key**

Press this key to return to the previous condition on the panel display.

**8. [▲][▼] keys**

Use these keys to increase or decrease values on the panel display when making settings.

**9. [# Enter] key**

Press this key to execute menu items selected on the panel display.

**10. [Media] key**

Use this key to select a tray, change the paper size, and to make other settings for printing.

**11. [Menu] key**

Press this key to make and check the printer settings.

**12. Power Indicator**

Stays on while the power is on. Stays off when the power is turned off or while the machine is in the Energy Saver mode.

---

**Selecting the printer language**



---

This shows how to select the printer language on the operation panel. Selecting the IPDL-C or the RICOH-SCRIPT2 (RPS2) printer language is required when you set the “menu” for each printer language.

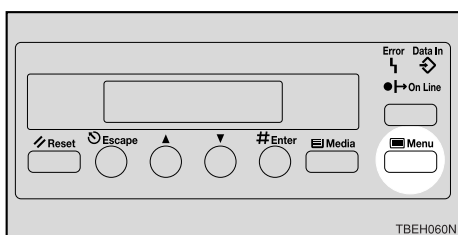
The printer language changes automatically when printing is processed.

**1** Press [Menu].

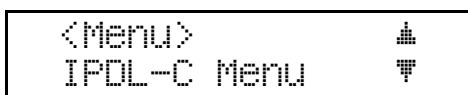
The following message appears on the panel display.

**2** Press [▲] or [▼] to display “System Menu”.

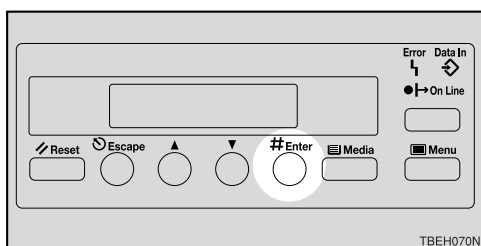
**3** Press **[# Enter]**.

The following message appears on the panel display.

```
<System Menu>  ▲
1.Paper Tray   ▼
```

**4** Press **[▲]** or **[▼]** to display “8. PrinterLang.”.

```
<System Menu>  ▲
8.PrinterLang. ▼
```

**5** Press **[# Enter]**.

The following message appears on the panel display.

```
<PrinterLang.> ▲
*IPDL-C        ▼
```

**6** Press **[▲]** or **[▼]** to display “RPS2”.

```
<PrinterLang.> ▲
*RPS2          ▼
```

**7** Press **[# Enter]**.

The following message appears on the panel display.

```
<System Menu>  ▲
8.PrinterLang. ▼
```

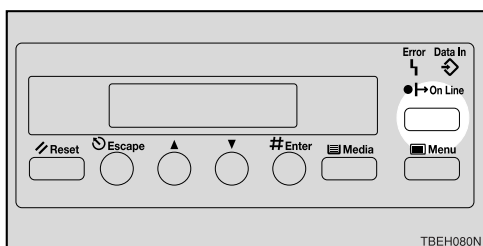
**8** Press **[On Line]**.

The following message appears on the panel display.

```
Take Offline  
Then Press Reset
```

**9** Press **[On Line]** to enter the offline mode.

The **On Line** indicator turns off.

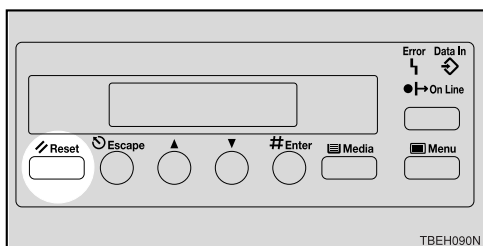
**10** Press **[Reset]**.

The printer resets and enters the RICOH-SCRIPT2 mode.

# 2. Configuring the Printer for the Network with the Operation Panel

## Configuring the Printer for the Network with the Operation Panel

Configure the printer for the network using the printer's operation panel.

The following table shows the operation panel settings and their default settings. These are included in the "System Menu".

	Items	Default
32	IP Address	011.022.033.044
33	Subnet Mask	000.000.000.000
34	Gateway Add (Gateway Address)	000.000.000.000
35	Access CTL. (Access Control Address)	000.000.000.000
36	Access Mask (Access Control Mask)	000.000.000.000
37	Net Boot (Network Boot)	None
38	Frame NW (Frame type NetWare)	Auto Select
39	Active PTL. (Active Protocol)	All Active

**1** Press **[Menu]**.

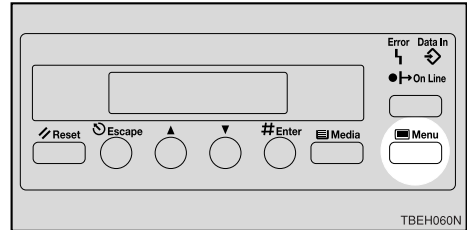

The following message appears on the panel display.

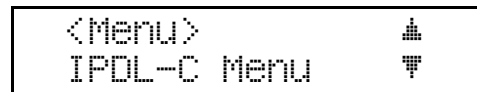

**2** Press **[▲]** or **[▼]** to display "System Menu".

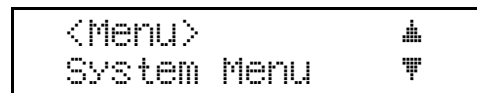

**3** Press **[# Enter]**.

The following message appears on the panel display.

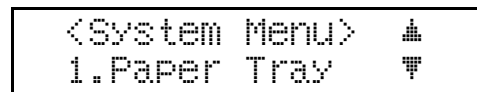

**4** Select the protocol you want to use. You can select one of the items on the table below.

Menu item on the panel display	Active Protocol			
	TCP *1	NW *2	ET *3	NB *4
All Active (Default Setting)	✓	✓	✓	✓
None				
TCP/IP Only	✓			
NetWare Only		✓		
TCP & NetWare	✓	✓		
EtherTalk Only			✓	
TCP & Ether-Talk	✓		✓	
NetW & Ether-Talk		✓	✓	
TCP & NW & Ether Talk	✓	✓	✓	
NetBEUI Only				✓
TCP & NetBEUI	✓			✓
NetW & Net-BEUI		✓		✓
TCP & NW & NB	✓	✓		✓
ETalk & Net-BEUI			✓	✓
TCP & ETK & NB	✓		✓	✓
NW & ETK & NB		✓	✓	✓

- ✓ means that this protocol is active.
- Blank cell means that this protocol is not active.

\*1 TCP/IP  
 \*2 NetWare  
 \*3 Ether Talk  
 \*4 NetBEUI

**Note**

❑ You should not select protocols that are not used on your network.

**1** Press [▲] or [▼] to display "39.Active PTL."



**2** Press [# Enter].

The current setting appears on the panel display.



**3** Press [▲] or [▼] to display the protocol you want to use.

**4** Press [# Enter].

The actual procedure may differ depending on the protocol you use. Follow the appropriate procedure.

TCP/IP	5▶6▶7▶8▶10
NetWare	9▶10
AppleTalk	10
NetBEUI	10

**5** If you use TCP/IP, you should assign the IP address to the printer.

**Note**

❑ To get the IP address for the printer, contact your network administrator.

**1** Press [▲] or [▼] until the following message appears.



**2** Press [# Enter].

The current IP address appears on the panel display.

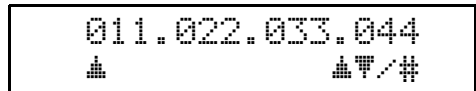

- 3 Press **[▲]** or **[▼]** to set the left-most digit of the IP address.

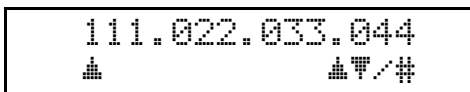

- 4 Press **[# Enter]**.  
The pointer (▲) moves to the next digit as shown.

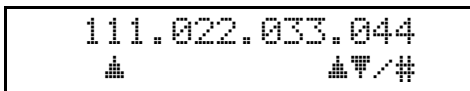

**Note**

- You can return the pointer (▲) to the previous (left) digit by pressing **[Escape]**.
- If you press **[Escape]** when the pointer (▲) is on the left-most position, the selected IP address is reset.

- 5 Press **[▲]** or **[▼]** to set the second digit of the IP address.

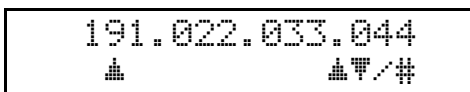

- 6 Press **[# Enter]**.
- 7 Repeat steps 5 and 6 to set the rest digit of the IP address.

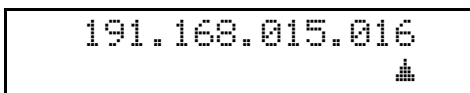

Check if the pointer (▲) is at the rightmost digit, and press **[# Enter]** to register the IP address you selected.

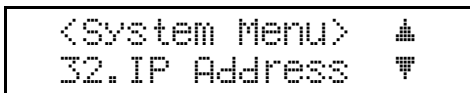

- 6 If you use TCP/IP, you should assign "33.Subnet Mask" and "34.Gateway Add" following the same procedure for setting the IP address.

- 7 If you use TCP/IP, set the "35.Access CTL." and "36.Access Mask" following the same procedure for setting the IP address, if necessary.

- 8 If you use TCP/IP, you should make settings for "37.Net Boot".

You can select how to assign the printer's address using the computer. Select one of the items on the table below.

Menu item on the panel display	Available method			
	AR *1	RA *2	BO *3	DH *4
None (Default Setting)				
RARP+TFTP		✓		
BOOTP			✓	
RARP & BOOTP		✓	✓	
DHCP				✓
ARP+PING	✓			
ARP & RARP	✓	✓		
ARP & BOOTP	✓		✓	
ARP & RARP & BOOTP	✓	✓	✓	

- \*1 ARP+PING
- \*2 RARP+TFTP
- \*3 BOOTP
- \*4 DHCP

**Note**

- You must configure your server to use "RARP+TFTP", "BOOTP" or "DHCP".

- 1 Press **[▲]** or **[▼]** to display "37.Net Boot".



- 2 Press **[# Enter]**.  
The current setting appears on the panel display.



- 3 Press **[▲]** or **[▼]** to display the method you want to use.
  - 4 Press **[# Enter]**.
- 9 If you use NetWare, select the frame type for NetWare.

Select one of items below if necessary.

- Auto Select (Default)
- Ethernet 802.3
- Ethernet 802.2
- Ethernet 2
- EthernetSNAP

**Note**

Usually, use the default setting ("Auto Select"). However, if you select "Auto Select", the frame type detected by the printer first is adopted. If your network can use more than two frame types, the printer may fail to select the correct frame type, if "Auto Select" is selected. In this case, select the appropriate frame type.

- 1 Press **[▲]** or **[▼]** to display "38.Frame NW".

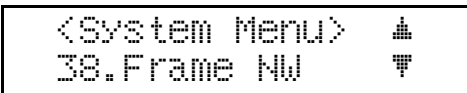

- 2 Press **[# Enter]**.  
The current setting appears on the panel display.



- 3 Press **[▲]** or **[▼]** to display the frame type you want to use.
  - 4 Press **[# Enter]**.
- 10 Reset the printer to apply the settings.

- 1 Press **[On Line]** to enter the offline condition.  
The On Line indicator turns off.

- 2 Press **[Reset]**.

- 11 Print the configuration page to check settings you have made.

- 1 Press **[Menu]**.
- 2 Press **[▲]** or **[▼]** to display "List Print".
- 3 After confirming that "Config.Page" is on the display, press **[# Enter]**.
- 4 Press **[# Enter]**.

The configuration page is now printed. Check the contents of the configuration page.

- 5 Press **[On Line]**.  
The "Ready" message appears on the panel display.

 **Address**
**❖ Subnet Mask**

A number used to mathematically “mask” or hide an IP address on the network by eliminating those parts of the address that are alike for all the machines on the network.

**❖ Gateway Address**

A gateway is a connection or interchange point that connects two networks. A gateway address is for the router or host computer used as a gateway.

 **Note**

- To get the addresses, contact your network administrator.

**❖ Access Control Address and Access Control Mask**

Access Control Address and Access Control Mask are used to control the IP addresses that have access to the computer used for printing, with the IP address. If it is not necessary for you to control the access rights, select “0.0.0.0”.

 **Note**

- When the Access Control Address settings coincide with the masked result of the IP address of the computer, print jobs from that IP address can be accepted by the Network Interface Board.
- For example, if you assign 192.168.15.16 as the Access Control Address to the Network Interface Board, the combination of the Access Control Mask and IP address that can have access are as follows. (xxx : for any numerical value)

Access Control Mask	IP Address that have access
0. 0. 0. 0	xxx.xxx.xxx.xxx
255. 0. 0. 0	192.xxx.xxx.xxx
255.255. 0. 0	192.168.xxx.xxx
255.255.255. 0	192.168. 15.xxx
255.255.255.255	192.168. 15. 16



2

# 3. Installing the Printer Driver and Software

All of the procedures in this manual assume that you are familiar with general Windows procedures and practices. If you are not, see the documentation that comes with Windows for details.

Some applications require their own specific settings, which may be different from those provided by the printer driver. Be sure to check the documentation that comes with your applications for detail.

Considerable hard disk space is required on your computer for printing complex documents.

# Before Installing

## ❖ PRINTER MANAGER

Installable PRINTER MANAGER may differ depending on the machine. See the table below.

Name of machine	Name of PRINTER MANAGER
Ricoh Aficio Color 3006, 4006, 4106	Aficio Manager for Admin
	Aficio Manager for Client
Gestetner CS206, CS206d, CS206de Savin SDC306, SDC306A, SDC306E	Net Vision for Admin
	Net Vision for Client
Lanier 5706AG, 5706AH, 5806AG, 5806AH, 5806E AG, 5806E AH	Lanier Net Manager for Admin
	Lanier Net Manager for Client

### Note

- Do not install another version of “Administrator” or “Client” at the same time.

## ❖ User Code

- With the IPDL-C printer driver, if you want to set a User Code, you must do it when installing the printer driver.
- With the RICOH-SCRIPT2 printer driver, only **[Off]** or **[On]** can be selected. The numerical value cannot be changed. If **[On]** is selected, “99999999” is automatically set as a default. So if you want to distinguish between the RICOH-SCRIPT2 and the IPDL-C printer drivers, set the different User Code in the IPDL-C printer driver.
- In Windows 95/98, if you want to change the User Code, reinstalling the printer driver is required.
- In Windows 95/98, changing the printer name makes the User Code ineffective. If you want to set the User Code again, reinstalling the printer driver is required.

# Auto Run Program

You can install the printer driver and utilities by using the Auto Run program. Auto Run is available for the following operating systems:

- Windows 95/98
- Windows NT 4.0

If you install the RICOH-SCRIPT2 (RPS2) printer driver, Auto Run is not available.

See P.25 “*Installing the RICOH-SCRIPT2 Printer Driver*”

## Important

- Before starting this installation, close all documents and applications. In a network environment, confirm that users who are logged on are disconnected. Be sure to do this when it creates the least interference with other users.

## Reference

For more information on the software and utilities included in the CD-ROM, see P.7 “*Software and Utilities Included in the CD-ROM*”.

## Note

- The Auto Run program might not automatically work with certain OS settings. In this case, start "Insttool.EXE" to install the printer driver on the root.
- If you want to cancel the Auto Run program, insert the CD-ROM while pressing the **[SHIFT]** key until your computer finishes accessing the CD-ROM.
- Recommended PC requirements.
  - Memory: 32MB or more
  - CPU: Pentium® 100MHz or more
  - Free Hard disk space: 100MB or more

---

## Installing by Auto Run

---

Follow these steps to install the printer driver and utilities on Windows 95/98/Windows NT 4.0.

## Important

- Never have two versions of the same printer driver installed on your system at the same time. When upgrading to a new version of the printer driver, delete the old version, and then install the new one.

## Note

- If the "plug and play" function is started by Auto Run, click **[Cancel]** in the **[New Hardware Found]** dialog box or **[Device Driver Wizard]**, and then insert the CD-ROM. **[New Hardware Found]** or **[Device Driver Wizard]** appears depending on the version of Windows 95/98.

**1** Close all applications that are currently running.

**2** Insert the CD-ROM in the CD-ROM drive.

**3** Select a language.

 **Note**

- The IPDL-C Printer Driver supports English, French, German, Italian or Dutch. If you have selected any other language, English Printer Driver will be installed. After installation, you can switch to another language in the Printer Properties.

**3**

**4** Follow the instructions on the screen.

**5** Restart your computer after installation is complete.

**6** You should set up the options with the printer driver.

# Installing the IPDL-C Printer Driver

## Windows 95/98 - Installing the IPDL-C Printer Driver

### Installing the printer driver

Install the driver in accordance with the steps explained. ⇒ P.21 "Installing by Auto Run"

### Setting up options

#### Note

- When setting up options, you should access the **[Configure Printer]** dialog box from Windows. You cannot set up options when accessing the **[Configure Printer]** dialog box from an application.

**1** Click **[Start]**, point to **[Settings]**, and then click **[Printers]**.

The **[Printers]** window appears.

**2** Select the icon of the printer you want to use by clicking it. On the **[File]** menu, click **[Properties]**.

**3** Click the **[Setup]** tab, and then click **[Configure Printer]**.

The **[Setup - Configure Printer ]** dialog box appears.

**4** Use the **[Option Selection]** list box to select the optional tray and sorter unit <sup>\*1</sup>.  
Selecting the wrong tray here will make it impossible to use your tray correctly.

<sup>\*1</sup> Among the optional sorter units, the 3-bin sorter does not support  $5\frac{1}{2}'' \times 8\frac{1}{2}''$   (HalfLetter).

#### Important

- If the optional tray is selected, be sure of the paper direction and paper size.
- With a duplex machine, select a duplex tray.

**5** Click **[OK]** to close the dialog box.

**6** Click **[OK]** to close the printer's Properties dialog box.

---

## Windows NT 4.0 - Installing the IPDL-C Printer Driver

---

### Limitation

- Installing a printer driver requires Full Control access permission. Members of the Administrators, Server Operators, Print Operators, and Power Users groups have Full Control permission by default. When you install a printer driver, log on using an account that has Full Control permission.

---

### Installing the printer driver

---

Install the driver in accordance with the steps explained. ⇒ P.21 *“Installing by Auto Run”*

Install the printer driver of Windows 95/98 for the alternative driver from the following folder in the CD-ROM: DRIVERS\IPDL\_C\WIN95\_98\DISK1

---

### Setting up options

---

- 1** Click [Start], point to [Settings], and then click [Printers].

The [Printers] window appears.

- 2** Select the icon of the printer you want to use by clicking it. On the [File] menu, click [Properties].

- 3** Click the [Configure Printer] tab.

- 4** Use the [Option Selection] list box to select the optional tray and sorter unit <sup>\*1</sup>.  
Selecting the wrong tray here will make it impossible to use your tray correctly.

<sup>\*1</sup> Among the optional sorter units, the 3-bin sorter does not support 5<sup>1</sup>/<sub>2</sub>" × 8<sup>1</sup>/<sub>2</sub>"  (HalfLetter).

### Important

- If the optional tray is selected, be sure of the paper direction and paper size.
- With a duplex machine, select a duplex tray.

- 5** Click [OK] to close the printer properties.

# Installing the RICOH-SCRIPT2 Printer Driver

---

## Windows 95/98 - Installing the RICOH-SCRIPT2 Printer Driver

---

With Windows 95/98, you should install both the Windows 95/98 PostScript printer driver and the PPD file.

### Note

- Be sure to install the PPD file for Windows 95/98. Be careful not to install the PPD file for Windows NT 4.0 accidentally.

---

## Installing the printer driver

---

### Preparation

The Windows 95/98 operating system CD-ROM or diskettes are required for installation.

The following procedure describes installation when the printer is connected to the computer via a parallel interface.

**1** Close all applications that are currently running.

**2** Click [Start], point to [Settings], and then click [Printers].

The [Printers] window appears.

**3** Double-click the [Add Printers] icon.

[Add Printer Wizard] starts.

**4** Click [Next].

**5** Check [Local printer], and click [Next].

A dialog box for selecting the printer manufacturer and model name appears.

**6** Click [Have Disk].

A dialog box for installing a driver from a disk appears.

**7** Insert the CD-ROM in the CD-ROM drive, while pressing the [SHIFT] key until the computer finishes accessing the CD-ROM.

If the Auto Run program starts, click [Cancel].

**8** Click [Browse].

### Note

- The Windows 95/98 printer driver is on the following folder in the CD-ROM: \DRIVERS\RPS2\WIN95\_98\*(language)*



- 9** Use the **[Drives:]** list box to select the CD-ROM drive.
- 10** In the **[Folders]** box, double-click **[DRIVERS]**, **[RPS2]** <sup>\*1</sup> and **[WIN95\_98]**. Then double-click the folder of the appropriate language. Finally, click **[OK]**.

\*1 RPS2 is the short name of RICOH-SCRIPT2.

- 11** Click **[OK]**.

- 12** Select the name of the printer whose driver you want to install by clicking it, and then click **[Next]**.

The port selection dialog box appears.

 **Note**

- If the printer is a **simplex** machine, select "Color Controller RC-200".
- If the printer is a **duplex** machine, select "Color Controller RC-200(D)".

- 13** In the **[Available ports]** box, select the printer port by clicking it, and then click **[Next]**.

- 14** Change the name of the printer if you want, and then click **[Next]**.

- 15** Select whether or not you want to print a test page, and then click **[Finish]**.

The installer copies the printer driver files from the CD-ROM to your computer's hard disk.

- 16** If you are asked to insert the Windows 95/98 system disk, insert it in the computer, and then click **[OK]**.

- 17** If you are asked to provide the location of the required file for Windows 95/98, do the following:

- Select the folder **[WIN95]** or **[WIN98]** in the system disk.
- Navigate to the folder where Windows is installed. Then, select the appropriate folder. The location of the appropriate folder may differ depending on the version of your operating system. The following are examples:  
   \WINDOWS\SYSTEM\OPTION\CABS  
   \WINDOWS\OPTION\CABS

- 18** If you are asked if you want to restart Windows, select **[Yes]**. If you are not asked, restart Windows after completing the installation.

- 19** After Windows restarts, set up any options you have installed to the printer.

 **Reference**

⇒ P.27 "Setting up options"

---

## Setting up options

---

- 1** Click **[Start]**, point to **[Settings]**, and then click **[Printers]**.

The **[Printers]** window appears.

- 2** Select the icon of the printer you want to use by clicking it. On the **[File]** menu, click **[Properties]**.

The Printer Properties appears.

- 3** Click the **[Device Options]** tab.

- 4** In the **[Installable Options]** box, select the options you have installed on the printer.

The current settings are displayed in the **[Change settings for:]** list box.

### Note

- The following items are available here: **[Paper feed Tray]**, **[Sorter]** <sup>\*1</sup>.

<sup>\*1</sup> Among the optional sorter units, the 3-bin sorter does not support 5<sup>1</sup>/<sub>2</sub>" × 8<sup>1</sup>/<sub>2</sub>"  (HalfLetter).

- 5** Use the **[Change settings for:]** list box to select the appropriate setting for the selected option.

- 6** Click **[Apply]** to apply the settings you made.

- 7** After configuring the appropriate settings, click **[OK]** to close the Printer Properties dialog box.

### Reference

You can confirm that the options are properly set by printing a configuration page.

---

## Windows NT 4.0 - Installing the RICOH-SCRIPT2 Printer Driver

---

With Windows NT 4.0, you should install both the Windows NT 4.0 PostScript driver and the PPD file.

### Limitation

- Installing a printer driver requires Full Control access permission. Members of the Administrators, Server Operators, Print Operators, and Power Users groups have Full Control permission by default. When you install a printer driver, log on using an account that has Full Control permission
- We recommend that you upgrade your Windows NT 4.0 operating system to the latest version before installing the printer driver. Contact your Windows retailer for details about the latest version available.
- Be sure to install the PPD file for Windows NT 4.0. Do not accidentally install the PPD file for Windows 95/98.

---

## Installing the printer driver

---

### Preparation

The CD-ROM containing the Windows NT Server operating system version 4.0, or the Windows NT Workstation operating system is required for installing the printer driver.

The following procedure describes installation when the printer is connected to the computer via a parallel interface.

**1** Close all applications that are currently running.

**2** Click **[Start]**, point to **[Settings]**, and then click **[Printers]**.

The **[Printers]** window appears.

**3** Double-click the **[Add Printer]** icon.

**[Add Printer Wizard]** starts.

**4** After confirming that the **[My Computer]** option is selected, click **[Next]**.

A dialog box for selecting the printer port appears.

**5** Check the check box of the port you want to use, and then click **[Next]**.

A dialog box for selecting the printer manufacturer and model appears.

**6** Click **[Have Disk]**.

A dialog box for installing a driver from a disk appears.

**7** Insert the CD-ROM in the CD-ROM drive, while pressing the **[SHIFT]** key until the computer finishes accessing the CD-ROM.

If the Auto Run program starts, click **[Cancel]**.

**8** Change the drive name in the list box to the name of the CD-ROM drive, and then click **[Browse]**.

#### Note

The Windows NT 4.0 printer driver is in the following folder on the CD-ROM: `\DRIVERS\RPS2\NT4\language`.

**9** In the **[Folders]** box, double-click **[DRIVERS]**, **[RPS2]** and **[NT4]**. Then double-click the folder of the appropriate language. Finally, click **[Open]**.

**10** Click **[OK]**.

A printer model selection dialog box appears.

**11** Select the name of the printer whose driver you want to install by clicking it, and then click **[Next]**.

A dialog box for changing the printer name appears.

 **Note**

- If the printer is a **simplex** machine, select "Color Controller RC-200".
- If the printer is a **duplex** machine, select "Color Controller RC-200(D)".

**12** Change the name of the printer if you want, and then click **[Next]**.

**13** Click **[Next]**.

**14** In the next dialog box asking if you want to print a test page, select **[No]** and then click **[Finish]**.

The installer copies the printer driver files from the CD-ROM to your computer's hard disk.

 **Note**

- Print a test page after completing installation and restarting Windows.

**15** If you are asked to insert the Windows NT 4.0 system disk, insert it in the computer, and then click **[OK]**.

**16** If you are asked to provide the drive of the system disk, use the drive containing the Windows NT 4.0 system disk.

**17** If you are asked to provide the location of the required file, select the appropriate folder. The location of the appropriate folder may differ depending on the version of your operating system. The following is an example:

- folder named **[i386]** of the Windows NT 4.0 system disk.

After installation is completed, the **[Printers]** window appears with the icon of the newly installed printer.

**18** If you are asked if you want to restart Windows, select **[Yes]**. If you are not asked, restart Windows after completing the installation.

**19** After Windows restarts, set up any options you have installed to the printer.

 **Reference**

⇒ P.29 "Setting up options"

---

## Setting up options

---

**1** Click **[Start]**, point to **[Settings]**, and then click **[Printers]**.

The **[Printers]** window appears.

**2** Select the icon of the printer you want to use by clicking it. On the **[File]** menu, click **[Properties]**.

The Printer Properties appears.

**3** Click the **[Device Settings]** tab.

**4** Under **[Installable Options]**, select the options you have installed on the printer.

The current settings are displayed in the **[Change Setting]** box in the lower part of the tab.

 **Note**

The following items are available here: **[Paper feed Tray]** and **[Sorter]** <sup>\*1</sup>.

<sup>\*1</sup> Among the optional sorter units, the 3-bin sorter does not support 5<sup>1</sup>/<sub>2</sub>" × 8<sup>1</sup>/<sub>2</sub>"  (HalfLetter).

**5** Use the **[Change Setting]** box to select the appropriate setting for the selected option.

**6** After making the settings you want, click **[OK]** to register the settings and close the Printer Properties dialog box.

 **Reference**

You can confirm that the options are properly set by printing a configuration page.

---

## Using Adobe PageMaker Version 6.0 or 6.5 in Windows

---

You should install the PPD file for PostScript printing with Adobe PageMaker.

---

### Installing the PPD files

---

**1** Close Adobe PageMaker if it is currently running.

**2** Insert the CD-ROM in the CD-ROM drive, while pressing the **[SHIFT]** key until the computer finishes accessing the CD-ROM.

If the Auto Run program start, click **[Cancel]**.

**3** Select the CD-ROM drive.

**4** In the **[Folders]** box, double-click **[DRIVERS]**, **[RPS2]** and **[WIN95\_98]**. Then double-click the folder of the appropriate language.

You can see the PPD file.

 **Note**

For Windows 95/98/NT 4.0, use the same PPD file included in the folder named `DRIVERS\RPS2\WIN95_98\language` in the CD-ROM that comes with the printer.

If the printer is a **simplex** machine, select "ricrc202.ppd".

If the printer is a **duplex** machine, select "ricrc2D2.ppd".

**5** Copy the PPD file into the appropriate folder. The location of the appropriate folder may differ depending on the version of software or how you installed the software on your operating system. The following are examples:

- Adobe PageMaker version 6.0: PM6\RSRC\PPD4
- Adobe PageMaker version 6.5: PM65\RSRC\<(language)\PPD4

---

### Selecting the PPD files

---

**1** Launch Adobe PageMaker.

**2** On the [File] menu, click [Print].

The [Print Document] dialog box appears.

**3** From the [Printers] list box, select the printer you want to use.

 **Note**

- Confirm that "RPS" is shown after the printer name.

**4** In the [PPD] list box, select the printer you want to use.

---

## Macintosh

---

Use the Macintosh LaserWriter 8 driver that comes with your operating system.

 **Important**

- See the documentation that comes with your operating system for details on the functions of the LaserWriter 8 printer driver.
- The PPD file is not compatible with QuickDrawGX.
- The LaserWriter printer driver for a Macintosh does not come with this printer. Use the appropriate printer driver that comes with the Macintosh operating system you are using.

 **Reference**

This manual describes only the settings specific for this printer. Settings actually may differ depending on the version of the LaserWriter driver you are using. See the documentation that comes with the Macintosh for details on the LaserWriter functions.

 **Note**

- The versions of the LaserWriter driver are separated into two categories. "LaserWriter 8.3x or earlier" refers to the LaserWriter 8.3x driver and all drivers before that. "LaserWriter 8.4x or later" refers to LaserWriter 8.4x, 8.5x and 8.6x. LaserWriter 8.5x was used to make this manual. The settings may differ depending on the version of the LaserWriter driver being used.

---

## Installing the PPD files

---

### Limitation

- Be sure to install the PPD file correctly. Otherwise, you cannot use the option, even though it is physically installed to the printer.

**1** Start the Macintosh.

**2** Double-click the icon of your hard disk to open it, and then open the [Extensions] folder inside the [System Folder] by double-clicking it.

**3** Insert the CD-ROM in the CD-ROM drive.

**4** Double-click the CD-ROM icon.

The contents of the CD-ROM appear.

**5** Double-click the [Printer Description] folder in the CD-ROM, and then double-click the folder having the appropriate language name to open it.

**6** Select the appropriate PPD file for the printer.

### Note

- If the printer is a **simplex** machine, install the PPD file named Printer Description:(language):Color Controller RC-200 in the CD-ROM.
- If the printer is a **duplex** machine, install the PPD file named Printer Description:(language):Color Controller RC-200(D) in the CD-ROM.

**7** Copy the PPD file in the [Printer Descriptions] folder located inside the [Extensions] folder.

The PPD file is installed.

---

## Installing the ColorSync profiles

---

ColorSync profiles make it possible for the printer to print colors of similar intensity to those that appear on your computer display. You must install the ColorSync profiles to use this feature.

### Note

- The ColorSync profiles conform with the color characteristics defined by the International Color Consortium (ICC).
- Some computer displays may require particular settings to be controlled by ColorSync. See the documentation that comes with your display for details.

The following profiles are provided for the printer.

**❖ RC-200 Transparency**

Adjusts the image density to optimize the output for the OHP projection. This profile is selected automatically whenever **[OHP Transparency]** is selected as the paper type.

**❖ RC-200 Presentation**

Enhances the reproduction of documents that contain text and graphics. This profile is best for printing charts, colored graphs, presentation materials and so on.

**❖ RC-200 Photograph**

Use this profile to enhance the reproduction of photos and graphics that include midtones.

**❖ RC-200 Solid Color**

Use this profile for printing specific colors, logos and so on.

The following procedure shows how to install the ColorSync Profiles.

**1 Start the Macintosh.****2 Double-click the icon of the hard disk to open it, and then open the appropriate folder for installing the ColorSync profiles.****Note**

The location of the appropriate folder may differ depending on the version of the operating system. The following are examples:

- System:Preferences:ColorSync Profiles
- System:ColorSync Profiles

**3 Insert the CD-ROM in the CD-ROM drive.**

The icon of the CD-ROM appears.

**4 Double-click the CD-ROM icon.**

The contents of the CD-ROM appear.

**5 Double-click the [ColorSync™ Profiles] folder in the CD-ROM to open it.****6 Copy all four files in the [ColorSync™ Profiles] folder.**

The ColorSync profiles are installed.

---

**Setting up PPD file**

---

**Preparation**

Confirm that the printer is connected to an AppleTalk network before performing the following procedure.

**1 On the Apple menu, select [Chooser].**



**2** Click the [LaserWriter 8] icon.

**3** In the [Select a PostScript Printer] list, select the name of the printer you want to use by clicking it, and then click [Create].

 **Note**

- If your network has multiple zones, click the name of the zone the printer belongs to in the [AppleTalk Zones] list in the lower left side of the [Chooser] dialog box.

**4** Select the name of the printer by clicking it, and then click [Select].

 **Note**

- Be sure to select the PPD file correctly. Otherwise, you may not use options because options that you can use depend on the printer.

The PPD file is set up and the LaserWriter 8 icon appears at the left of the printer name in the list. Next, follow the procedure on P.34 “Setting up options” to make the option settings, or to close the [Chooser] dialog box.

---

## Setting up options

---

**1** On the Apple menu, select [Chooser].

**2** Click the [LaserWriter 8] icon.

**3** In the [Select a PostScript Printer] list, select the name of the printer you want to use by clicking it, and then click [Setup].

 **Note**

- If your network has multiple zones, click the name of the zone the printer belongs to in the [AppleTalk Zones] list in the lower left side of the [Chooser] dialog box.

**4** Click [Configure].

A list of options appears.

**5** Select the option you want to set up and the appropriate settings for it.

 **Note**

- If the option you want to set up does not appear, the PPD file has not been set up correctly. Check the name of the PPD file shown in the dialog box.

 **Reference**

For more information on setting up options, see the “Operating Instructions” for RICOH-SCRIPT2 provided as a PDF file which is included in the CD-ROM.

**6** Click [OK].

The list of options closes.

**7** Click [OK].

The [Chooser] dialog box appears.

---

## Installing screen fonts

---

The screen fonts described below can be found in the CD-ROM, in the folder named [Fonts].

Screen fonts are 10, 12, 14, 18 and 24 point bitmap fonts. Other sizes make characters appear with ragged edges on your computer screen, but they print with smooth edges.

 **Note**

- The screen fonts included in the CD-ROM are as follows: AG-Ricoh, HN-Ricoh, CS-Ricoh, BM-Ricoh, ZC-Ricoh, ZD-Ricoh.

**1** Start the Macintosh.**2** Insert the CD-ROM in the CD-ROM drive.

The CD-ROM icon appears.

**3** Double-click the CD-ROM icon.

The contents of the CD-ROM appear.

**4** Copy the fonts you want to install in the [System] folder.

A confirmation dialog box appears.

**5** Click [OK].

The fonts are installed.

**6** Restart the Macintosh. **Note**

- The names of the fonts you have installed appear in the pull-down menu when you select fonts with applications.

---

 **Screen Fonts**

Screen fonts are bitmap fonts, which are formed by grouping dots together. Because of this, screen fonts appear jagged on your computer screen when you enlarge or reduce them. It is recommended that you install as many different sizes as possible for each font to avoid such jagged appearances. Screen fonts are provided for this printer in 10, 12, 14, 18 and 24 point sizes.

---

# INDEX

---

10BASE-T/100BASE-TX, 1

## A

---

Access Control Address, 13, 17  
Access Control Mask, 13, 17  
Active Protocol, 13  
Adobe PaerMaker, 30  
    *PPD, installing*, 30  
Auto Run, 21  
    *Installing*, 21

## D

---

Data In indicator, 9

## E

---

**[# Enter]** key, 10  
Error indicator, 9  
**[Escape]** key, 10

## F

---

Frame type NetWare, 13

## G

---

Gateway Address, 13, 17

## I

---

IP Address, 13  
IPDL-C, 7  
    *Windows 95/98 - Install*, 23  
    *Windows NT 4.0 - Install*, 24

## L

---

LaserWriter, 31

## M

---

Macintosh, 31  
    *ColorSync, installing*, 32  
    *PPD, installing*, 32  
    *PPD, Setting up*, 33  
**[Media]** key, 10  
**[Menu]** key, 10

## N

---

Network Boot, 13  
Network Connections, 2  
Network Interface Boad, 3

## O

---

On Line indicator, 9  
**[On Line]** key, 10  
Operation Panel, 9  
Options, 23, 24, 27, 29, 34

## P

---

Panel Display, 9  
Parallel Cable, 2, 4  
Parallel Port, 1  
Power indicator, 10  
printer driver, 7  
PRINTER MANAGER, 20

## R

---

**[Reset]** key, 10  
RICOH-SCRIPT2, 7  
    *Windows 95/98 - Install*, 25  
    *Windows NT 4.0 - Install*, 27

## S

---

Screen Fonts, 35  
Subnet Mask, 13, 17

## U

---

User Code, 20  
    *statistics report*, 6  
User ID  
    *job log*, 6